

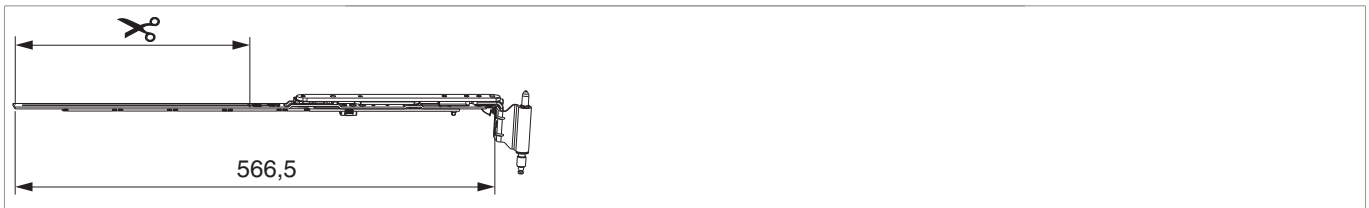







223682 - Schere montiert MM 180 kg V3 rechts 670 12/20-13 FFB 401-670 Titan - S

Technische Zeichnung



									No
Titan - S	rechts	12/20-13	670	401 - 670	310 - 400	211	180	10	223682

Schraubpositionstabelle

No		1	2	3	4	5	6	7	8	9
223682	3	19	154	165						

Zapfensitztablelle

No		Z1	Z2	
223682	0			



Stanzbild



- 1. Stulp
- 2. Riegel

Klipsverbindung

Klipsverbindung einhängen



Klipsverbindung aushängen



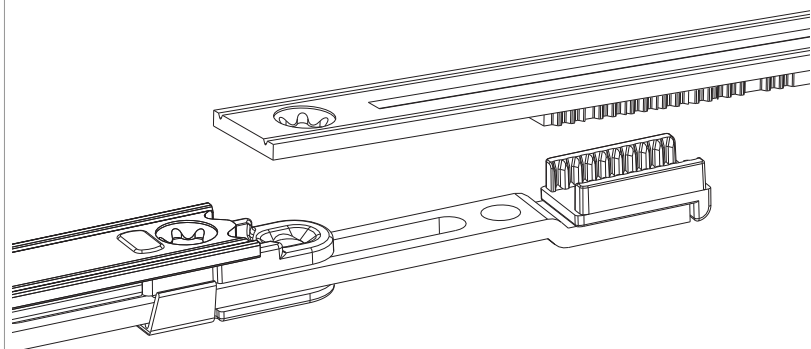

Zahnkassenverbindung

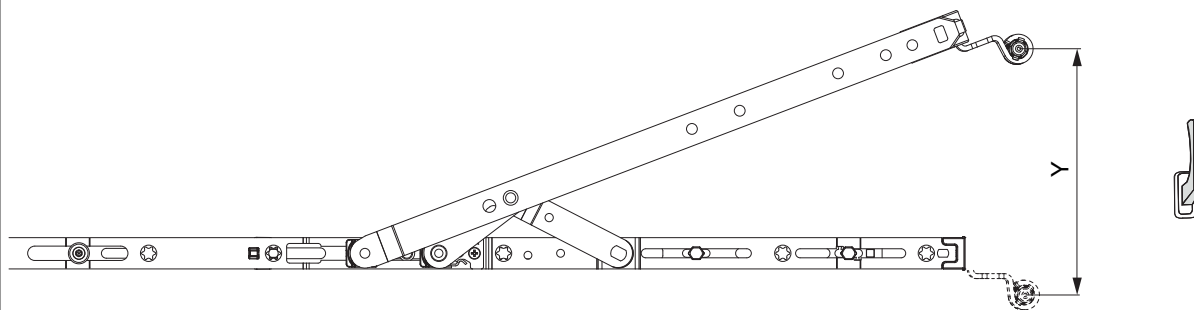

Öffnungsweite

Kippstellung



	Y
600	128
900	128
1200	128
1500	128

Anpressdruckregulierung

i.S Zapfen und Verschlusszapfen

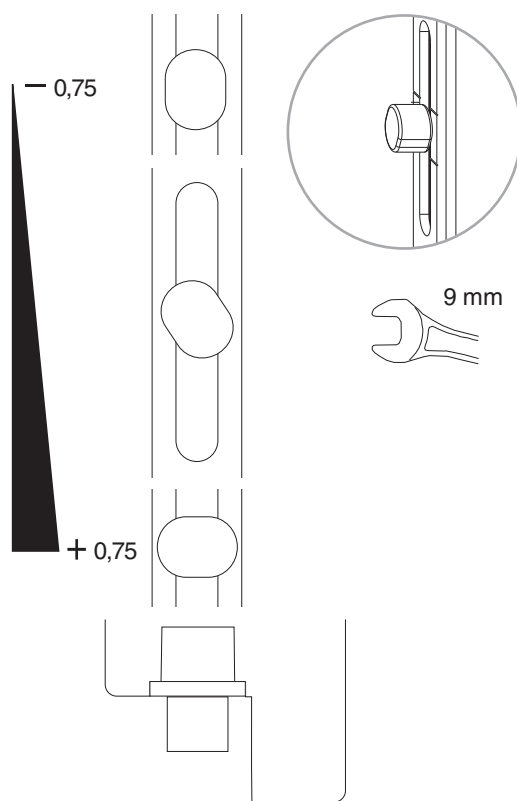
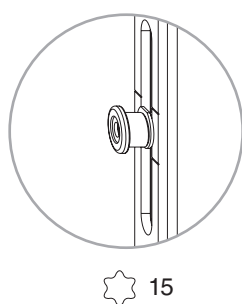
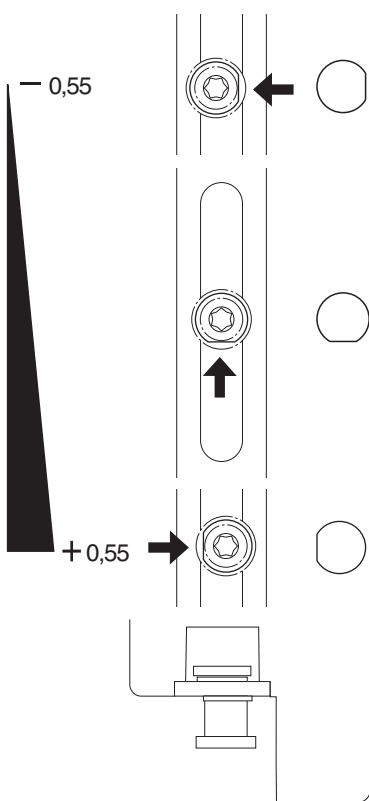
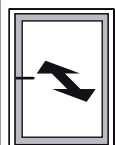

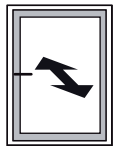

Achtung: Eckumlenkung mit Zapfen bzw. Mittelverschluss EH zur Anpressdruckregulierung verwenden.