

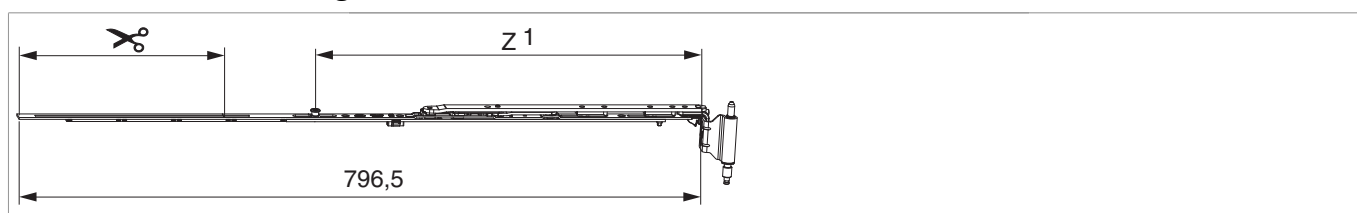

223620 - Schere montiert MM 180 kg V3 rechts 900 12/20-13 FFB 671-900 mit 1 i.S. Silber

Technische Zeichnung



Silber	rechts	12/20-13	900	671 - 900	601 - 670	240	180	10	223620

Schraubpositionstabelle

		1	2	3	4	5	6	7	8	9
223620	5	19	92	234	351	414				

Zapfensitztablelle

		Z1	Z2	
223620	1	450		



Stanzbild

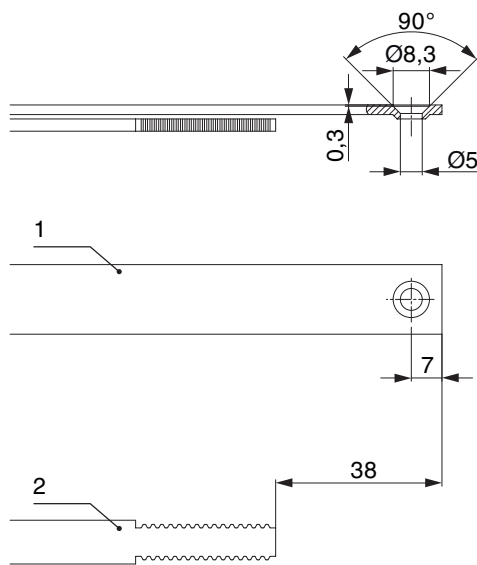

- 1. Stulp
- 2. Riegel

Klipsverbindung

Klipsverbindung einhängen



Klipsverbindung aushängen



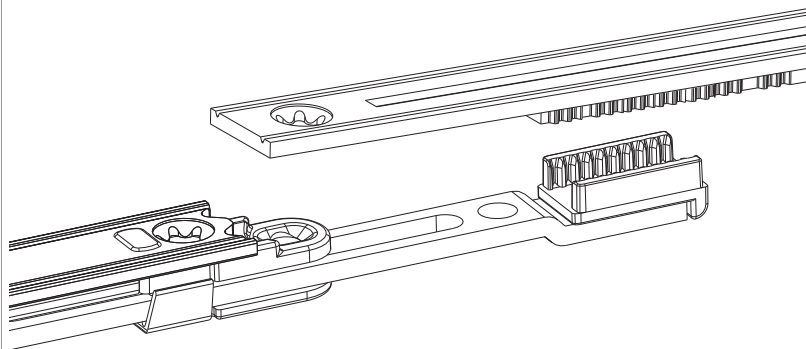

Zahnkassenverbindung

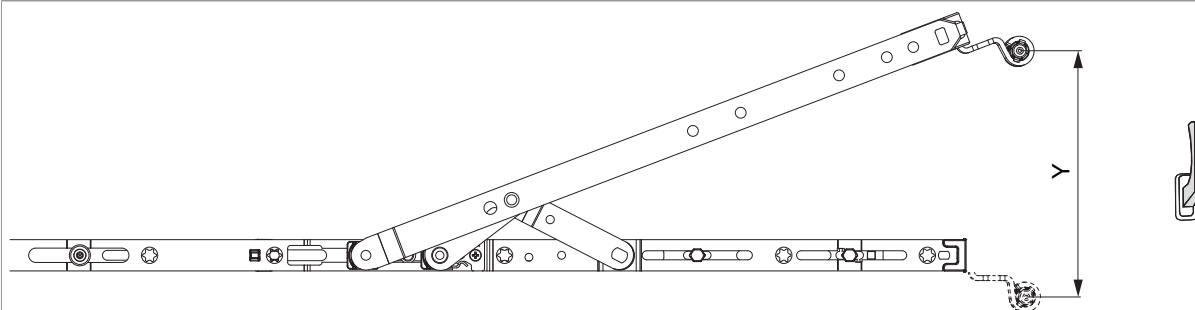

Öffnungsweite

Kippstellung



	Y
600	128
900	128
1200	128
1500	128

Anpressdruckregulierung

i.S Zapfen und Verschlusszapfen

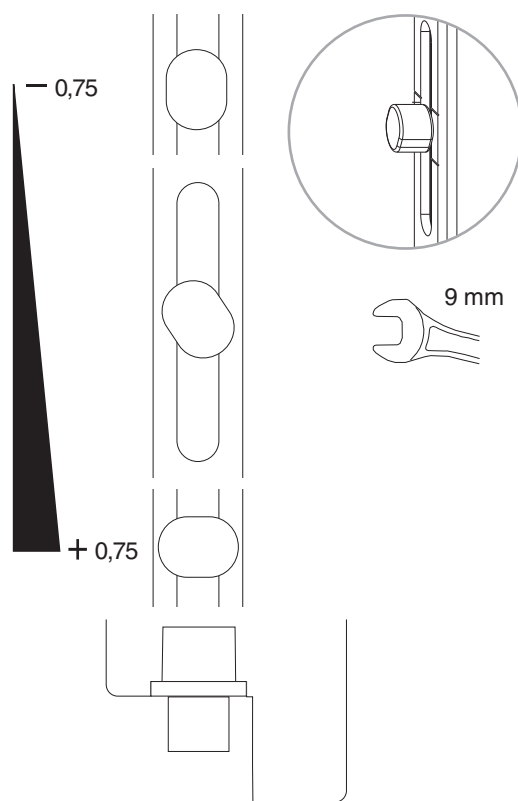
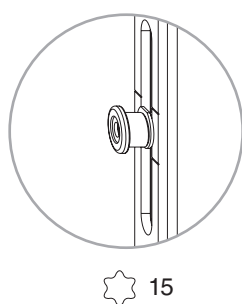
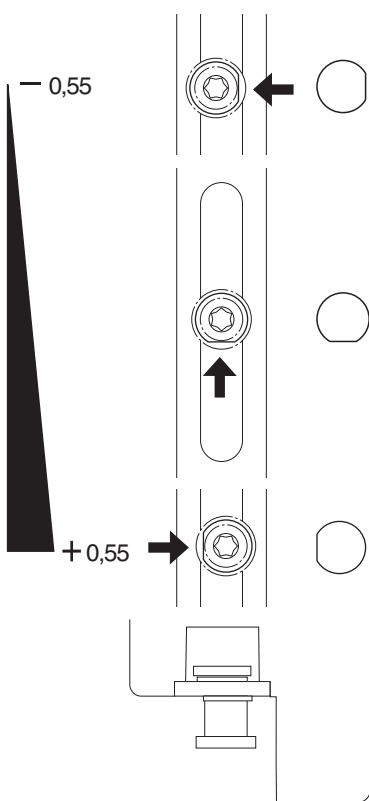
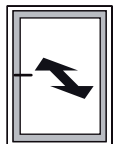

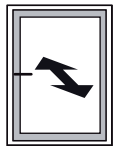

Achtung: Eckumlenkung mit Zapfen bzw. Mittelverschluss EH zur Anpressdruckregulierung verwenden.