

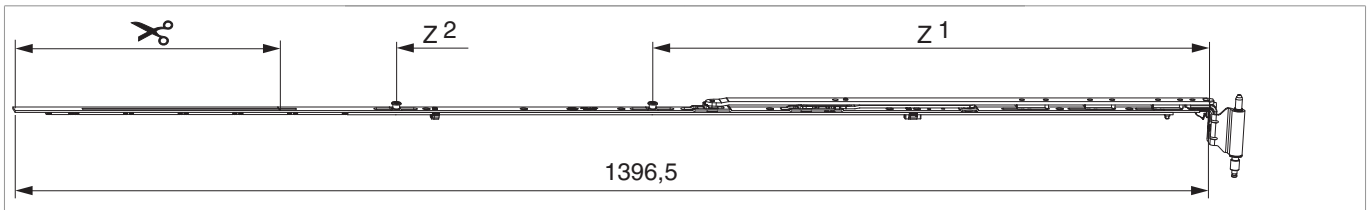









223609 - Schere montiert MM 180 kg V3 links 1500 12/18-13 FFB 1.201-1.500 mit 2 i.S. Silber

Technische Zeichnung



									
Silber	links	12/18-13	1500	1.201 - 1.500		310	180	5	223609 ¹⁾

¹⁾Ab FFB 1401 mm ist die Verwendung der Zweitschere vorgeschrieben.

Schraubpositionstabelle

No		1	2	3	4	5	6	7	8	9
223609	9	19	92	173	340	372	512	686	800	914

Zapfensitztable

No		Z1	Z2
223609	2	650	950



Stanzbild



- 1. Stulp
- 2. Riegel

Klipsverbindung

Klipsverbindung einhängen

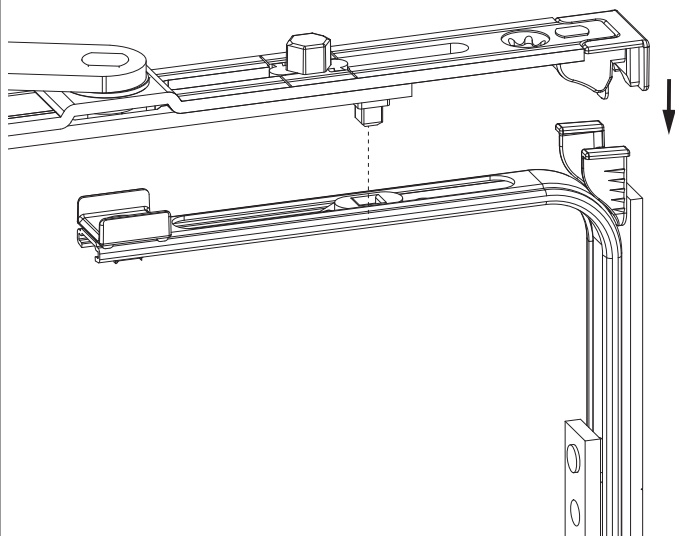

Klipsverbindung aushängen

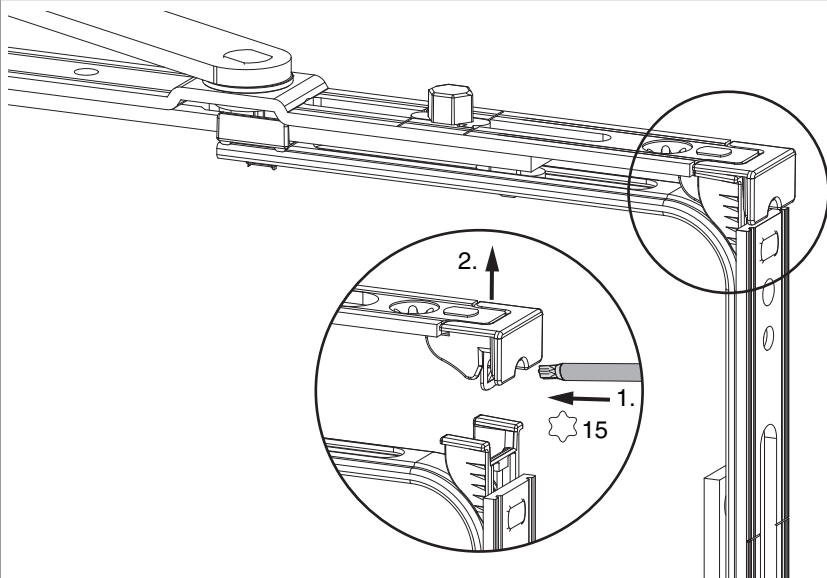

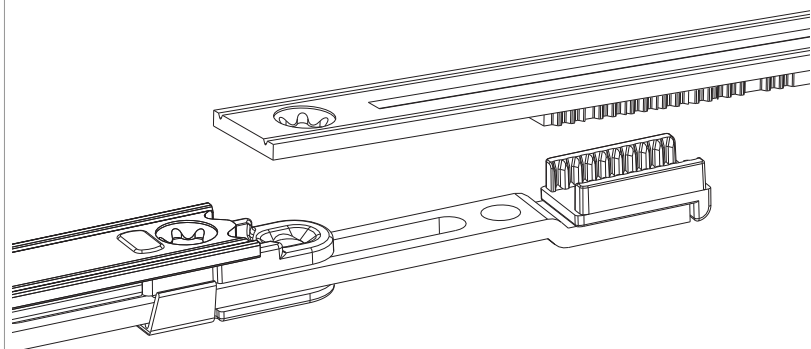

Zahnkassenverbindung

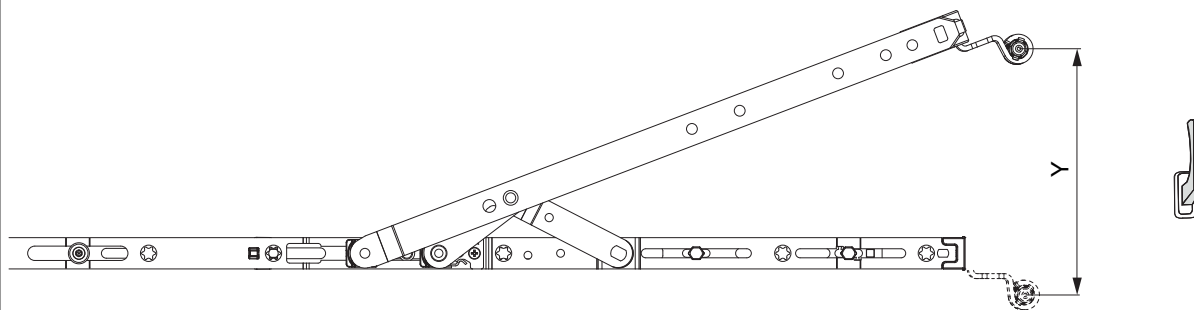

Öffnungsweite

Kippstellung



	Y
600	128
900	128
1200	128
1500	128

Anpressdruckregulierung

i.S Zapfen und Verschlusszapfen

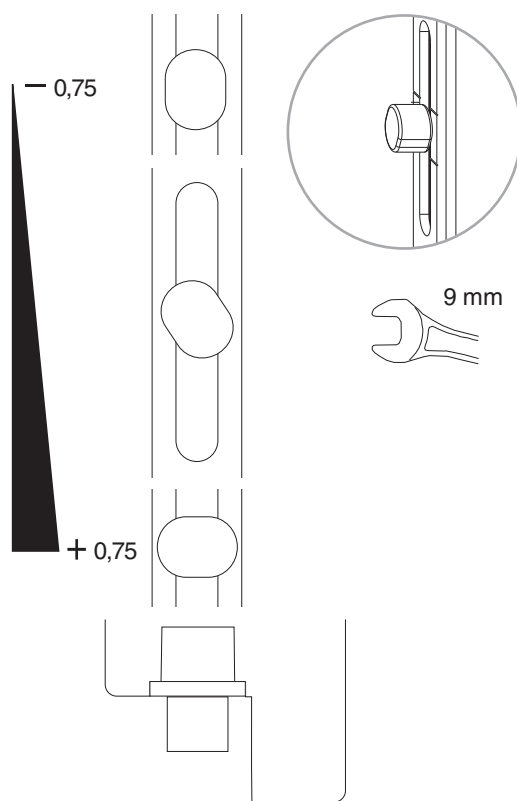
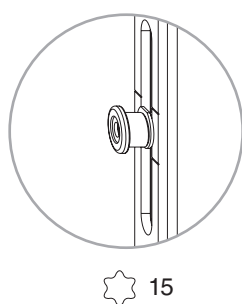
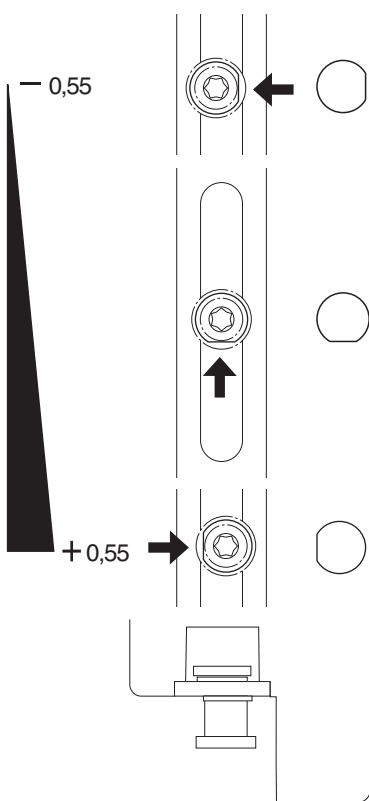
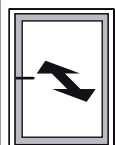

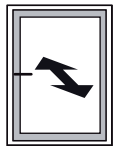

Achtung: Eckumlenkung mit Zapfen bzw. Mittelverschluss EH zur Anpressdruckregulierung verwenden.