

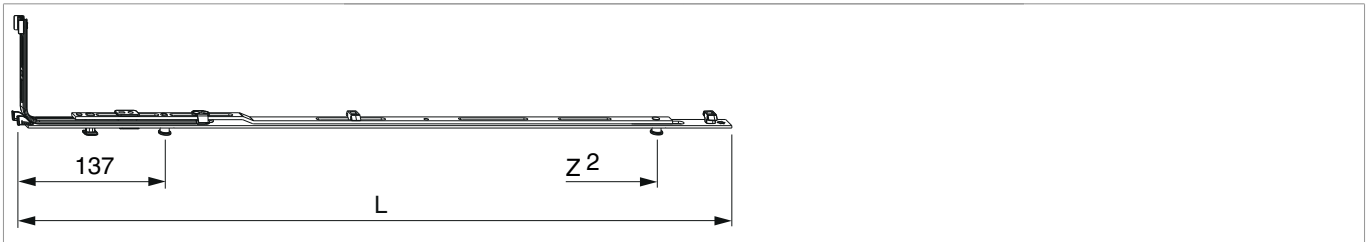





211937 - Kippverschluss einteilig MM 1280 mit 2 i.S. FFH/FFB 801-1.280 Silber

Technische Zeichnung



			L			No
Für Anwendungsbereich 801 - 900 mm Artikelnummer 211937 (Kippverschluss einteilig Gr. 1280) verwenden.						
Silber	1280	mit 2 i.S.	652,5	801 - 1.280	20	211937 ¹⁾

¹⁾Einzusetzen bei nach EN 1627 gefertigten Fenstern.

Schraubpositionstabelle

No		1	2	3	4	5	6	7	8	9
211937	5	106,5	174	300	521	645,5				

Zapfensittztable

No		Z1	Z2	Z3
211937	2	137	586	

Einbau der Eckumlenkung

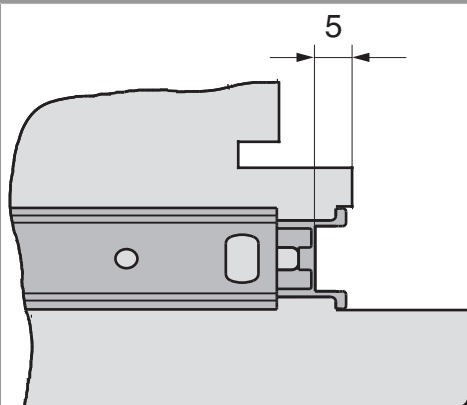

Achtung: Stulpversatz beachten!

Position des Kippschließteils

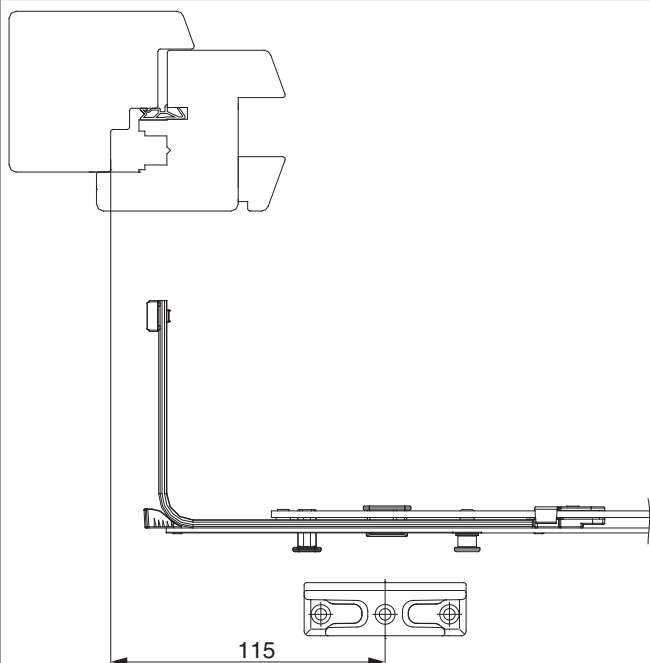

Anpressdruckregulierung

i.S Zapfen und Verschlusszapfen

